



Anti water hammer combination air valve

Mod. FOX 3F - AS

The CSA air valve Mod. FOX 3F AS will ensure the proper operation of the pipeline network allowing the release of air pockets during working conditions, the entrance of large volumes of air during draining operations and pipeline bursts and the air discharge with controlled speed, to prevent water hammer.



Technical features and benefits

- Body in ductile cast iron, PN 40 bar rated, provided with internal ribs for consistent and accurate guiding of the mobile block.
- Drainage valve produced by CSA, for chamber control and pressure relief during maintenance.
- Mobile block composed of a cylindrical float and upper disk in solid polypropylene, joined together by the CSA air release system in AISI 316 (pat. Pending). The solid cylindrical floats, obtained by CNC machining only, avoid deformations and ensure a great sliding precision inside the body processed ribs and a perfectly vertical thrust.
- Nozzle and gasket holder, part of CSA air release system, entirely made in AISI 316 and designed with gasket compression control to prevent aging process and consequent leakage during working conditions.
- Maintenance can be easily performed from the top, without removing the air valve from the pipe.
- Anti water hammer system (also called AS function), never in contact with water, obtained by a spring and shaft in stainless steel, disk with adjustable sonic nozzles for air flow control.

Applications

- Main transmission lines.
- Water distribution networks.
- Irrigation systems.
- In general this model is used near pumps, on changes in slope ascending, and at the high points of the pipeline subjected to water hammer.

Operating principle

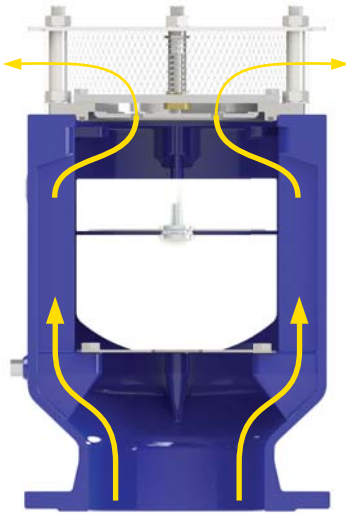

Controlled air discharge

During the pipe filling it is necessary to avoid rapid closures, responsible of water hammer effects. The FOX 3F AS, thanks to the anti-shock feature, will control the air outflow thus reducing the velocity of the approaching water column. The risk of overpressure will therefore be minimized.

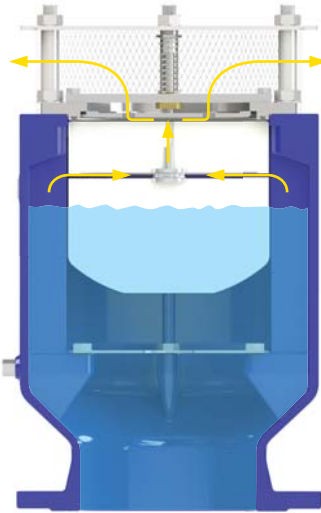

Air release during working conditions

During operation the air produced by the pipeline is accumulated in the upper part of the air valve. Little by little it is compressed and the pressure arrives to water pressure, therefore its volume increases pushing the water level downwards allowing the air release through the nozzle.

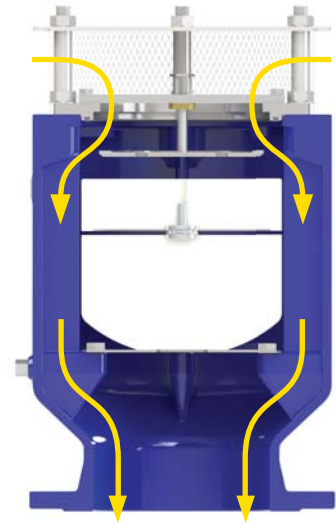

Entrance of large volumes of air

During pipeline draining, or pipe bursts, it is necessary to bring in as much air as the quantity of outflowing water to avoid negative pressure and serious damages of the pipeline, and to the entire system.

Optional



■ **Vacuum breaker version Mod. FOX 2F AS**, to allow the entrance of large volumes of air and the controlled outflow only. This model is normally recommended in changes in slope ascending, long ascending segments, dry fire systems.



■ **Version for submerged applications, SUB series**, available both for FOX 3F AS and 2F AS Models, with elbow for air conveyance. The design sprang from the necessity of having an air valve performing also in case of flood, without the risk of contaminated water entering the pipeline. Another benefit of SUB is to avoid the spray effect, conveying spurts coming from the closure away from the air valve.



■ The counteracting spring force as well as the sonic nozzles, both responsible of the proper operation of the AS device, can be modified on request according to the project conditions and the transient analysis.

Air flow performance charts

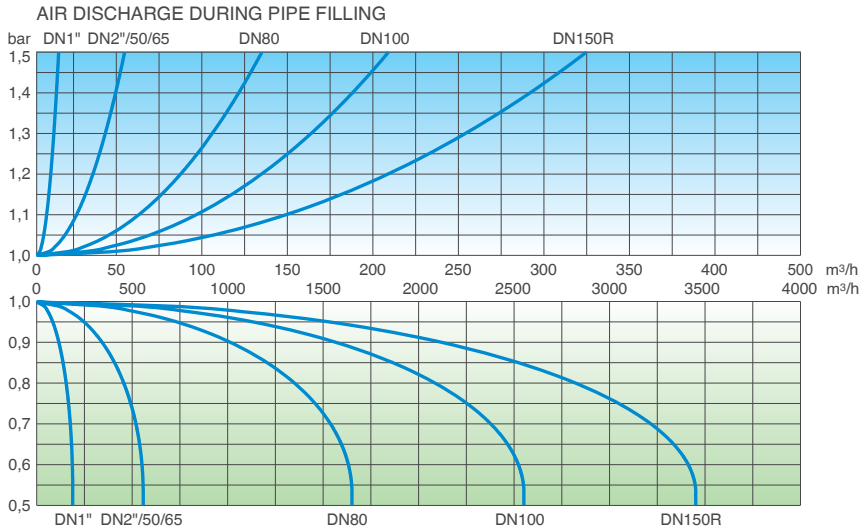

The air flow charts were created in Kg/s from laboratory tests and numerical analysis, then converted using a safety factor.

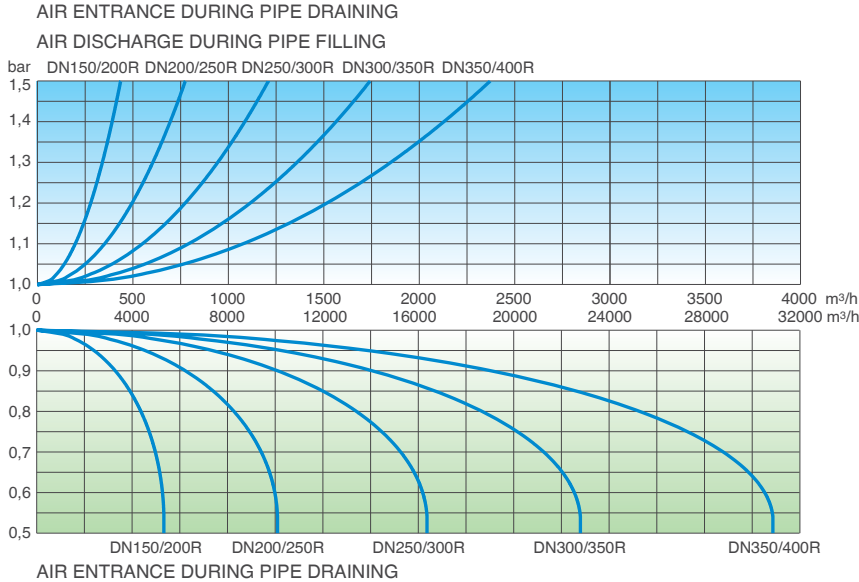
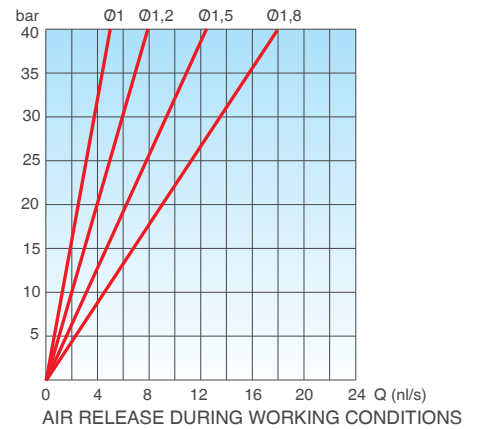

Working conditions

Treated water max. 60°C;
 Max. pressure 40 bar;
 Min. pressure 0,3 bar;
 Low pressure version to 0,19 bar on request.

Standard

Designed in compliance with EN-1074/4 and AWWA C-512.
 Flanges according to EN 1092/2.
 Epoxy painting applies through fluidized bed technology blue RAL 5005.
 Changes and variations on the flanges and painting details available on request.

CONNECTION inch/mm	A mm	B mm	C* mm	C** mm	D mm	Weight Kg
Threaded 1"	93	217	=	=	CH 45	3,3
Threaded 2"	118	277	=	=	CH 75	6,1
Flanged 50	118	290	165	165	=	8,1
Flanged 65	118	290	185	185	=	8,6
Flanged 80	142	322	200	205	=	11,1
Flanged 100	180	364	220	235	=	18,5
Flanged 150R	218	435	285	300	=	34,5
Flanged 150	261	500	285	300	=	49,0
Flanged 200R	261	500	340	340	=	51,0
Flanged 200	333	596	340	375	=	94,0
Flanged 250R	333	596	=	400	=	102,0
Flanged 250	414	735	=	450	=	121,0
Flanged 300R	414	735	=	485	=	127,0
Flanged 300	492	850	=	515	=	240,0
Flanged 350R	492	850	=	580	=	250,5
Flanged 350	570	995	=	580	=	295,0
Flanged 400R	570	995	=	660	=	304,0

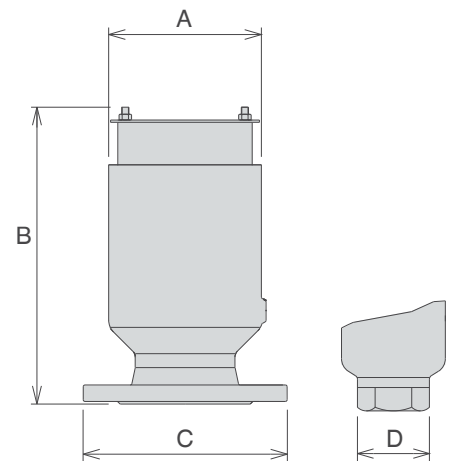

* M.F. = mobile flanges version
 ** F.F. = fixed flanges version

Technical details

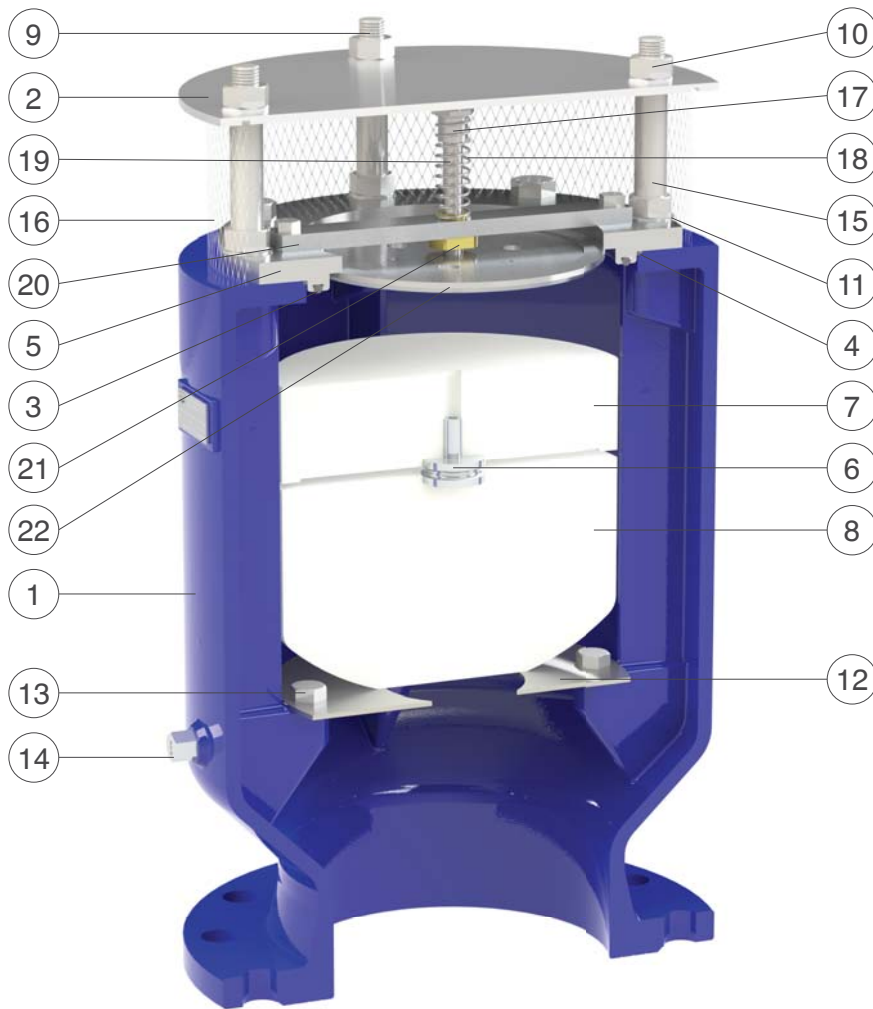

Version with cap and mesh in stainless steel, M series, available from 1" up to DN 400.



Version with cap in ductile, C series, available from 1" up to DN 150.

N.	Component	Standard material	Optional
1	Body	ductile cast iron GJS 500-7	
2	Cap	stainless steel AISI 304	stainless steel AISI 316
3	O-ring	NBR	EPDM/Viton/silicone
4	O-ring	NBR	EPDM/Viton/silicone
5	Seat	stainless steel AISI 304	stainless steel AISI 316
6	Nozzle subset	stainless steel AISI 316	
7	Upper flat	polypropylene	
8	Float	polypropylene	
9	Studs	stainless steel AISI 304	stainless steel AISI 316
10	Nuts	stainless steel AISI 304	stainless steel AISI 316
11	Washer	stainless steel AISI 304	stainless steel AISI 316
12	Diffuser	stainless steel AISI 304	stainless steel AISI 316
13	Screws	stainless steel AISI 304	stainless steel AISI 316
14	Drainage valve	stainless steel AISI 303	stainless steel AISI 316
15	Spacers	stainless steel AISI 304	stainless steel AISI 316
16	Filter	stainless steel AISI 304	
17	Spring guide nut (from DN 100)	stainless steel AISI 303	stainless steel AISI 316
18	Spring	stainless steel AISI 302	
19	AS shaft	stainless steel AISI 303	stainless steel AISI 316
20	Support, screws (from DN 150R)	stainless steel AISI 304	stainless steel AISI 316
21	Guiding nut (from DN 150R)	Delrin (polyoxymethylene)	
22	AS flat	stainless steel AISI 304	stainless steel AISI 316

The list of materials and components is subject to changes without notice.